

C16-A25PTL

2 pole | 8-pin | changeover contact | Grid 5mm

| | |
|---|----------------------|
| Maximum contact load | 7 A/250V AC-1 |
| | 7 A/30V DC-1 |
| Recommended minimum contact load | 1 mA/1V AC/DC |

Contacts

| | |
|------------------------------|----------------------|
| Material | ⚡ AgSnO ₂ |
| Rated Load | 7 A |
| Switching voltage max. | 250V |
| Max. inrush current (500 ms) | 15 A |
| Bounce time | 2 ms |

Coil

| | |
|-----------------|---|
| Coil resistance | see table; tolerance ± 10 % |
| Pick-up voltage | 75 % of U _N (DC) / 80 % of U _N (AC) |
| Release voltage | ≤ 0.1 U _N (DC) / ≤ 0.3 U _N (AC) |
| Nominal power | 1 VA (AC) / 0.53 W (DC) @ 23 °C |

Coil Data (DC voltage)

| Coil Voltage Code | Nominal Voltage (V DC) | Coil Resistance (Ω) ± 10 % | Must operate voltage max. (VDC) | Must release voltage min (VDC) |
|-------------------|------------------------|----------------------------|---------------------------------|--------------------------------|
| 12 | 12 | 270 | 9.00 | 1.2 |
| 24 | 24 | 1080 | 18.00 | 2.4 |
| 36 | 36 | 1350 | 27.00 | 3.6 |
| 48 | 48 | 4340 | 36.00 | 4.8 |
| 110 | 110 | 22830 | 82.5 | 11 |

Coil Data (AC voltage 50/60Hz)

| Coil Voltage Code | Nominal Voltage (VAC) | Coil Resistance (Ω) ± 10 % | Must operate voltage max. (VAC) | Must release voltage min (VAC) | Max. allowable voltage (VAC) |
|-------------------|-----------------------|----------------------------|---------------------------------|--------------------------------|------------------------------|
| 24 | 24 | 253 | 19.2 | 7.2 | 26.4 |
| 110 | 110 | 5819 | 88.0 | 33 | 121 |
| 230 | 230 | 23276 | 184 | 69 | 253 |

Insulation

| | |
|---|-----------------------------|
| Insulation resistance (coil to contact) | ≥ 100 MΩ @ 500V DC, 50 % RH |
| Dielectric strength | 5 kV |
| Contact/coil | 5000 Vrms, 1 min |
| Contact/contact | 1000 Vrms, 1 min |

Specifications

| | |
|---------------------------------------|--------------------------------------|
| Ambient temperature operation/storage | -55 ... 70 °C / -55...70 °C (no ice) |
| Pick-up time | 10ms |
| Release time | 5 ms |
| Mechanical/electrical life ops | ≥ 1 × 10 000 000 / 1 × 100 000 |
| Weight | 17 g |
| Max. switching frequency | 20Hz |
| Tightness | RT2 |

Product References

V AC 50 Hz/60 Hz: 24, 110 (120), 230 (240)
V DC 12, 24, 48

C16-A25PTL/AC...V
C16-A25PTL/DC...V

Other voltages on request

"..." List Coil Voltage to complete Product References

Accessories

| | |
|-------------------------|-----------------------------------|
| Socket | S16-M |
| Retaining clip, plastic | CP-16 |
| Modules | See datasheet socket S16-M |



Connection diagram

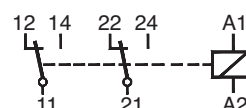
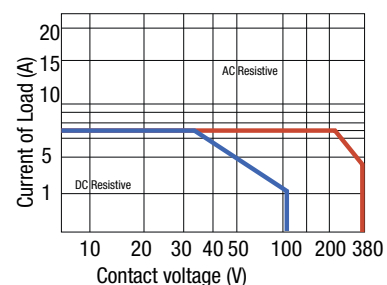
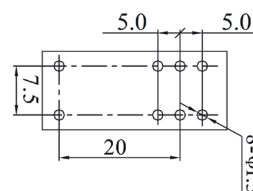
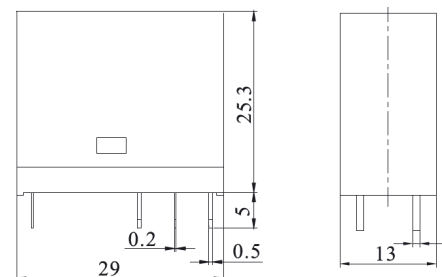

fig. 1 Max. Operating Power Curve



Dimensions (mm)



Technical approvals, conformities



IEC/EN 61810; IEC/EN 60947

Industrial Relays

General Information

Product range

ComatReleco offers a wide range of relay types and versions and associated sockets and accessories.

Industrial Relays C2, C3, C4, C5

35 x 35 mm round plug-in relay, 8- or 11-terminals multipole connector according to IEC 67 with 2 or 3 contacts up to 10 A and different contact types and contact materials. Standard relay 35 x 35 mm with flat blade connectors with up to 4 contacts and up to 16 A with 4 contacts.

Industrial Relays C7, C9

22.5 mm series with up to 4 contacts and up to 10 A with 1 or 2 contacts.

Interface Relays, C10, C12, C16, C18

Overall width 13 mm with up to 2 electro-mechanical contacts, or fully electronic switches.

Special relays, remanence relays

While "normal" relays are monostable, i.e. they return to the idle state when the excitation is switched off, remanence relays are bistable, i.e. the current switching state is retained irrespective of the excitation. Relays of this type are available in different versions.

Solid State Relay CSS

CSS Relays are suitable to either switch AC or DC loads up to 6 A. For AC relays a distinction is made between synchronously (zero crossing) and asynchronously switching versions. For switching transformer loads we recommended using asynchronously switching semiconductor switches. For incandescent lamp loads etc. synchronously switching switches are ideal for avoiding high switch-on currents.

Accessories

Suitable sockets are available for the different relay series for DIN rail mounting or panel mounting. In addition, retaining clips are available for the relays, some of which are included in the scope of supply. Suitable bridges for cost-saving wiring in series are also available.

(*) Special requirements

H = Orange button. No lockable function
N = Black button. No function
P = PCB pins

E = Lap transparent cover
T = Close transparent cover (lamp)

PT = PCB pins, 3.5mm grid, transparent cover
PTL = PCB pins, 5mm grid, transparent cover

Basic identification principle (type designation code electromechanical relays)

C **n(n)** - **T** **X** **y** **z(*)z** **/...V** **RF-nnnn**

Ref. nnnn

Relays with a reference number are versions with special (e.g. customised) features. These features may relate to special test criteria, tolerances or other properties.

Availability of such relays may be limited to certain customers or applications.

Nominal coil voltage specification

| | |
|----------------|-------------------------|
| AC ... V | AC 50/60 Hz, |
| | voltage 6 – 250 (400) V |
| AC ... V 60 Hz | AC 60 Hz, 120, 240 V |
| DC ... V | DC, voltage 5 – 220 V |
| UC ... V | AC/DC |

X = Electric position indicating device with LED

Describes the options

D = Integrated free-wheeling diode
F = Integrated free-wheeling diode and series diode e.g. for common alarm circuits
R = RC connection for the coil
B = Bridge rectifier
PT = Transparent PCB Relay with 3mm Grid
PTL = Transparent PCB Relay with 5mm Grid

Definition of contact material

This code may differ depending on type.

Examples:

0 in the standard range stands for AgNi
1–9 see contact material for each type

Number of contacts

Relay type

A = Standard (general-purpose) contact
E = Sensitive drive with 500 mW coil power
G = Refers to a NO contact
H = Single-point contact + twin contact load to signal current circuit for switching state feed back. Mixed contact configuration
M = Relay with highly effective neodymium blow magnet for fast quenching of the arc. This relay is particularly suitable for high DC loads.
N = Sensitive drive 800 mW coil power
R = Code for remanence relays, drive-specific ID
S = Sensitive drive with 250 mW exciter input
T = Twin contact for signal and control circuit
W = With tungsten contact for maximum switch-on currents
X = Relay high power, double make contact.
B = Single C.O. contact with two pins per connection

Basic type refers to the product line

Numbers between 2 and 12 and 20, 30 are used.

Normal industrial relay code

Relays with code R are used for railway series.

Coil accessories General Information

Industrial Relays C2-C9

Protection against transients

When the coil is disconnected from an electromagnet, peaks of inverse voltage appear at the terminals which can reach very high values. These pulses can be transmitted down the line associated with the coil and could possibly affect other components. In the case of a relay being operated by such devices as transistors, Triacs, etc; it may be necessary to protect against transients.

Transients carried in the line

High voltage surges can be carried in the supply line to the relay coil. These may appear in the form of peaks or bursts and are generated by the connection and disconnection of electric motors, transformers, capacitors etc. Normally a relay is unaffected by these pulses, but if a diode is connected in association with the coil, it must be capable of withstanding an inverse voltage higher than those of the incoming peaks.

Protection circuits

A protection circuit must efficiently cope with pulses generated by the coil as well as incoming line surges (surges $U_{1.2/50\mu s}$). ComatReleco Relays are available with integrated protection circuits or with modules plugged into sockets S3-M, S3-M0 or S3-M1.

X LED indication with rectifier.
For DC and AC relays up to 250 V
Note: LED connected, in series with the coil @ 220 V DC in QRC types.

DX Free-wheeling diode + LED
Dampens transients caused by the relay coil on de-energisation.

FX Polarity + free wheeling diode + LED
A diode in series with the coil protects the relay from reverse connection.

BX Bridge rectifier + LED indication
Allows the relay to operate in both AC or DC without any polarity inconvenience. Available only in voltages up to 60 V.

R Resistor and capacitor.

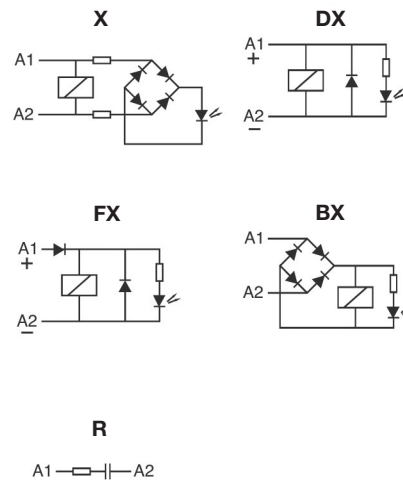

Industrial Relays C10-C18

LED and protection circuit connected to coil.

- X** LED with no polarity, (standard)
Coils ≤ 12 V A DC coils
LED rectifier bridge in parallel
- X** LED with no polarity, (standard)
Coils ≥ 24 V A DC coils
LED rectifier bridge in series
- FX** LED with polarity **A1+** (option)
Every DC coil voltage
Polarity and Free-wheeling diodes
- BX** LED with no polarity, (option)
Only 24 V and 48 V A DC coils
Rectifier bridge for AC/DC relays
- R** LED not available (option)
RC protection against pulses on AC

Protection against pulses

When a relay coil is disconnected, reverse voltage peaks may arise and reach very high values. Said peaks can transmit to the coil associated line and other relays or semiconductors can be affected.

If Triac, transistor, etc. controls a relay, appropriate steps must be taken to avoid or decrease peaks down to a non risky level.

Both Polarity and Free-wheeling diodes (**FX**), must protect coils, to avoid malfunctions provided DC relays in battery are installed.

Making or breaking engines, transformers or contactors in an industrial environmental, may generate high voltage pulses, either isolated or burst, through the main line.

The voltage level of those pulse may be high enough to affect the isolation of the coil.

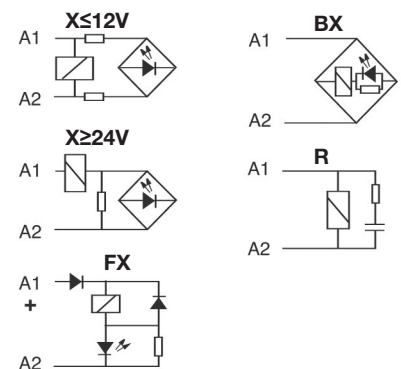

Contacts

There are different contact types. The main distinction is between single contacts and twin contacts. While single contacts are more suitable for higher loads, twin contacts are significantly more reliable at small loads, i.e. <math>< 24V, < 100mA.</math>

Contact Material

There is no all-purpose contact!

AgNi is used as standard material for a wide range of applications. AgNi contacts with hard gold plating (up to 5µm) are offered for applications in aggressive atmosphere.

Relays with gold contacts are approved for relatively high currents (e.g. 6A, 250V), but in practice values of 200mA, 30V should not be exceeded for operation with intact gold plating.

Relays with a tungsten pre-contact are available for very high switch-on currents (up to 500A, 2.5ms). For some applications AgNi contacts with gold flashing (0.2µm) are available. The purpose is corrosion protection during storage. Tin oxide is specially appropriated for load with high-inrush current.

Minimum load

The minimum load value is a recommended value under normal conditions such as regular switching, no special ambient conditions, etc. Under these conditions reliable switching behaviour can be expected.

Contact resistance

Initial values of resistance of contact can vary with the use, load and others conditions. Typical values when the relay is new is about 50mΩ.

Contact spacing

Normally all contacts have an air gap between 0.5 ... 1.5mm when they are open. They are referred to as µ contacts. According to the Low-Voltage Directive and the associated standards these contacts are not suitable for safe disconnection.

For switching of DC loads large contact clearances are beneficial for quenching the arc. See relays with "Cx-Gyz" naming. "G" stands for extended contact gap of 3mm.

Switching capacity

The contact switching capacity is the product of switching voltage and switching current. For AC the permitted switching capacity is generally high enough to handle the max. continuous AC-1 current over the whole voltage range. For DC the load limit curve must never be exceeded, because this would lead to a remaining switch-off arc and immediate destruction of the relay. The order of magnitude of the DC switching capacity is a few 100W (DC-1).

Drive (coil)

The drive of a relay refers to the coil plus connections.

The coil has special characteristics, depending on the rated voltage and the type of current.

Coil design

The coil consists of a plastic former (resistant up to about 130°C) and doubly insulated high-purity copper wire, temperature class F. The winding must withstand threshold voltages (EN 61000-4-5) of more than 2000V. This is ensured through forced separation of the start and end of the winding.

Coil resistance and other properties

Each coil has an ohmic resistance that can be verified with an ohmmeter. The specified coil resistance applies to a temperature of 20°C. The tolerance is ±10%.

For AC operation the coil current will not match the ohmic value, because self-inductance plays a dominant role. At 230V this may reach more than 90H. When a relay is switched off, self-inductance results in a self-induced voltage that may affect the switching source (destruction of transistors, EMC problems).

Drive voltages

A distinction is made between the standardised voltages according to EN 60947 as guaranteed values, and typical values that can be expected with a high degree of probability.

Pick-up voltage, Release voltage

The pick-up voltage is the voltage at which the relay engages safely. For DC the typical trip voltage is approx. 65% of U_{nom} , for AC approx. 75%. The release voltage, on the other hand, is approx. 25% or 60% respectively. For DC these voltages are strongly temperature-dependent, according to the temperature coefficient of Cu. This is not the case for AC, where the inductive resistance is the controlling factor, which is practically constant over a wide temperature range.

With AC, in a certain undervoltage range the relay may hum, and the armature may flutter. This voltage range must be avoided.

Operating voltage range

Unless specified otherwise, the following characteristic curve applies for the operating voltage range. The upper limit of the coil voltage is determined by self-heating and the ambient temperature. Self-heating through contacts under high load must not be underestimated. It may be higher than the power dissipation in the drive.

During intermittent operation significantly higher overvoltages temporary may occur for short periods. If in doubt please consult our specialists.

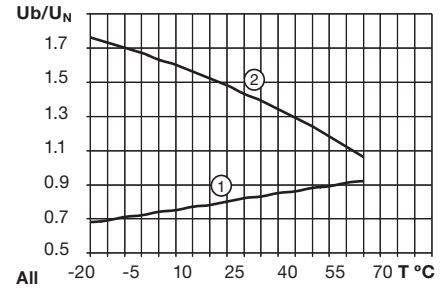

General design

ComatReleco Relays are made from high-quality, carefully selected materials.

They comply with the latest environmental regulations such as RohS. Their meticulous design makes them particularly suitable for industrial applications and installation engineering.

They are particularly service-friendly through robust terminals, mechanical position indicating device a standard, manual operation, dynamic, permanent characteristics. Colour coding for manual operation as a function of the coil voltage is another useful feature. Further options such as different coil connections, free-wheeling diode, LED display, bridge rectifier for AC/DC drives etc., and short-term availability of special versions for practically any drive voltage up to DC 220V / AC 400V leave nothing to be desired. Apart from a few special versions, in general, ComatReleco industrial relays feature manual operation (push/pull) and a mechanical position indicating device.

For safety reasons, manual operation may be replaced with a black button, if required.

Coil connections

Different coil connections can be integrated in the relay as an option.

For DC a cost-effective free-wheeling diode is available. Please note that the stated release times are generally specified without the coil connection.

While an additional LED status indicator has practically no effect, a free-wheeling diode (D) will lead to an increase in release time by a factor 2 to 5, or 10ms to 30ms. For AC VDRs or RC elements may be used. In this case resonance effects may have to be considered. VDRs and common RC elements may increase release times by less than 5 ms.

Industrial Relays

General Information

Standards, conformities

All ComatReleco relays feature the CE mark to indicate that CE standards apply e.g. 2kV surge resistance according to EN 61000-4-5. A significant and not generally available characteristic is that the coils and in particular the connections are able to withstand the voltage spikes that may occur in practice. In addition, the relays feature various technical approvals depending on the respective relay code, and they comply with further standards and guidelines. The main technical approvals include cURus, CCC, Lloyd's Register, cULus and EAC. The associated information is provided in the data sheets.

Switching classes

EN 60947 defines different switching classes that specify the suitability of contacts for different load types.

Example:

AC-1 = Ohmic AC load
 AC-3 = Motor loads
 AC-15 = Power contactors, solenoid valves, solenoids
 DC-1 = Ohmic DC load
 DC-13 = DC contactors, solenoids



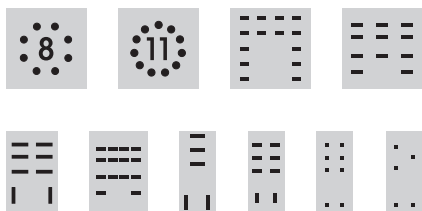

UL60947 contains different technical approval criteria such as general purpose, control application etc. Switching classes are defined based on the electrical switching capacity, e.g. B600 etc.

Choosing the right Socket

For plug-in industry, interface, time, and monitoring relays, we offer sockets with the corresponding pin configuration and various layouts for the terminal connectors. For easy identification, you'll find those symbol referring to the matching socket.



Main technical approvals and standards

| Country | Technical approval |
|-------------------------------|--|
| China |  Authority: CQC Specification GB14048.5-2001 |
| Russia |  Authority: KORPORATSIA STANDART Specification TP TC 004/2011 |
| World Wide USA / Canada |  Authority: UL Specification C 22.2; UL 60947 |
| United Kingdom |  Authority: GB Lloyd's Register of Shipping |

Utilisation categories according to EN 60947-4-1/-5-1

Pollution category

Cat. 1

Dry, non-conductive contamination without further effect

Cat. 2

Occasional conductive contamination, short duration due to moisture condensation

Cat. 3

Dry, non-conductive and conductive contamination with moisture condensation

Cat. 4

Contamination with persistent conductivity through conductive dust, rain

Protection class IP according to EN 60529 and other standards. Industrial relays and their sockets can be classified as follows:
 Socket IP20: Contact safety
 Relay IP40/IP50: not watertight, but protected against ingress of coarse contaminants.

Electrical Distributor DIN 45mm

All devices with a housing fitting in an electrical distributor with a front of 45mm are marked with the following symbol.

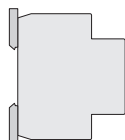

Further information and tips

The main operational criteria for relays such as number of cycles, switching frequency, ambient conditions, reliability requirements, load type, switch-on current, load switch-off energy must be clarified in order to ensure reliable operation and long service life.

Example

If the number of cycles is expected to exceed several 100.000 operations per year (e.g. clock generators, fast running machines), an electronic solution is no doubt more appropriate, although we also offer solutions for this type of application. In AC applications crosstalk caused by long control leads is often a problem and can result in constant humming of the relay or even inadvertent triggering due to interference.

Different harmless loads may lead to very high switch-on currents or switch-off energy values, resulting in an unacceptable reduction in service life.

Particularly tricky are DC inductive loads.

Characteristics of various loads:

Heating circuits

No higher switch-on currents, no higher switch-off loads.

Incandescent lamps, halogen lamps

Switch-on currents during a few ms in the range 10 ... 18 x rated. Switch-off at rated load.

Low-energy lamps

Very high, but very short switch-on currents due to built-in decoupling capacitors. Contacts have a tendency to fuse.



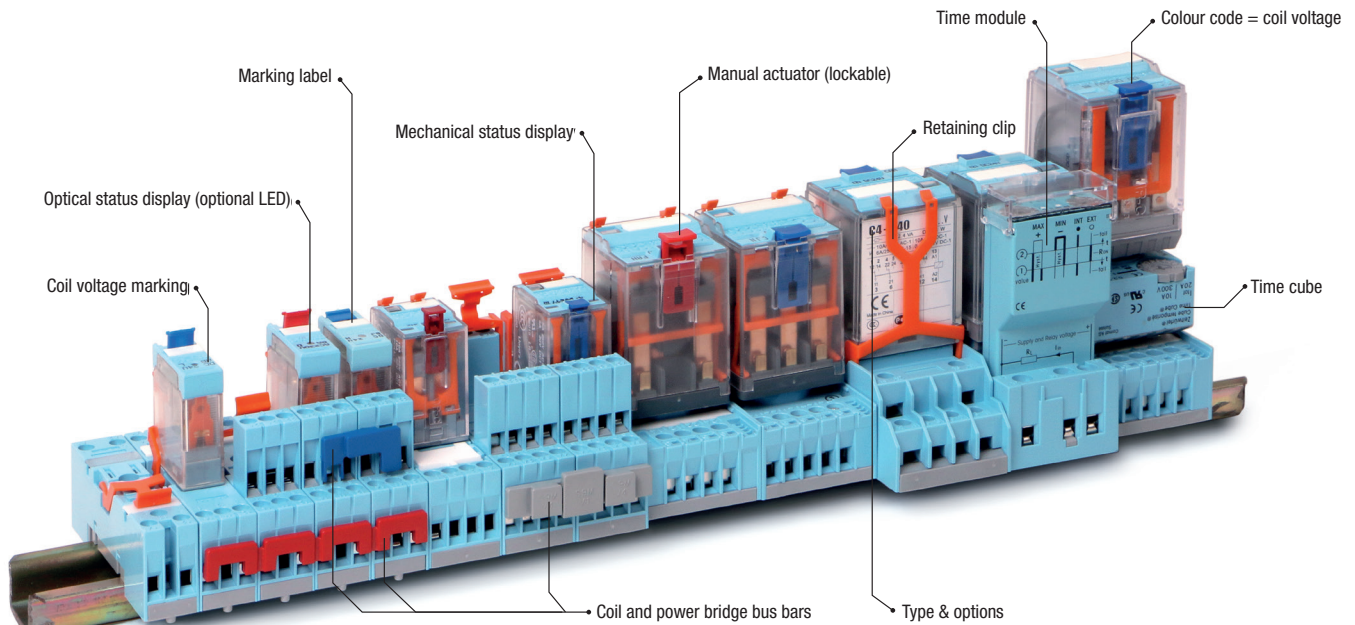

Transformers, AC contactors

Switching on during zero-transition may lead to switch-on currents of 8 ... 15 x rated. High inductive switch-off energy is possible. The load must be connected, not least due to EMC problems.





- X** LED
- DX** Freewheeling diode, LED
- BX** Bridge rectifier, LED
- FX** Polarity protection, freewheeling diode, LED

Five colours for an easier identification of coil voltage

-  **AC** red: 230 V AC (North America 120 V AC)
-  **AC** dark red: others V AC
-  **UC** grey: V AC/DC
-  **DC** blue: 24 V DC
-  **DC** dark blue: others V DC

If you don't want to have the lockable function, you can use the orange button.

-  Orange button, no lockable function, push only
-  Black button, no function

Comprehensive technical label

C3-X10 — Part number

— AC 2.8 VA DC 1.3 W — Coil details

— 10A/250V AC-1 | 10A/30V DC-1 — Maximum switching capacity according to EN 60947 (IEC 947)





Wiring diagram showing terminals 3, 9, 2, 10, A1, A2.

CE, UL US, 10A 250 Vac, 10A 30 Vdc, Made in India — Approvals

Additional circuit diagram for coil Electric diagram showing all additions to the coil

Wiring diagram with sequential and DIN numbers

- Level of switching current and voltage of the application?
- DC or AC switching?
- Inductive or capacitive load?
- Expected number of switching cycles?

| Symbol | Voltage | Current | Use | Type | Material |
|--|-------------|---------------|---|----------------------------|------------------------------------|
|  Signal relays | 100 mV...5V | 10 uA...1 mA | Low-level signals, Standard signals (0...10V/4...20mA) | Gold-plated double contact | AgNi + Au |
| | | | | Gold-plated Single Contact | AgNi + Au |
|  Control relays | 5V...30V | 1 mA...100 mA | PLC inputs, Control circuits | double contact | AgNi |
| | | | | Gold-plated Single Contact | AgNi + Au |
| | | | Frequent, rapid switching procedures | Semiconductor | Mosfet (DC) Triac (AC) |
|  Power relays | 30V...400V | 100 mA...16A | Increased AC or DC loads | Single Contact | AgNi |
| | | | Electromagnets (utilisation cat. AC-15/DC-13) | Single Contact | AgSnO ₂ |
| | | | Frequent, rapid switching procedures, high reliability, noiseless switching | Semiconductor | Mosfet (DC) Triac (AC) |
|  High-power relays | 12V...400V | 100 mA...16A | Capacitive loads | Early make contact | AgNi + W AgSnO ₂ + W |
| | | | High DC loads, inductive loads | Series contacts | AgNi AgSnO ₂ |
| | | | Frequent, rapid switching procedures, high reliability, noiseless switching | Semiconductor | Mosfet (DC) Triac (AC) |

S16-M

Socket for 8-pin Relays

Rated Load **10 A / 300 V**

Specifications

| | |
|----------------------------------|--|
| Rated impulse withstand voltage | 3 kV rms / 1 min |
| - All terminals / DIN rail | 3 kV rms / 1 min |
| - Terminal / Terminal | 3 kV rms / 1 min |
| - Terminal / Coil | 3 kV rms / 1 min |
| Cross-section of connecting wire | |
| - Single-wire | 1 × 0.5 mm ² / AWG 20 |
| - Multi-wire | 1 × 2.5 mm ² / AWG 14 or 2 × 1.0 mm ² / AWG 18 |
| Nominal screw torque | 0.7 Nm |
| Screw Dimensions (mm) | M3 Pozzi 1 slot 2 |
| Mounting | TS-35 or Back Panel Mounting |
| Ambient temperature | -40...60 °C / -40 ... 80 °C (no ice) |
| Weight | 42 g |



Connection diagram

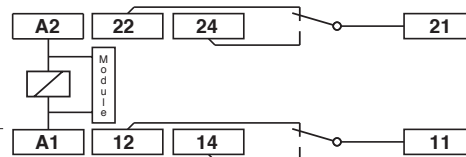

Dimensions (mm)

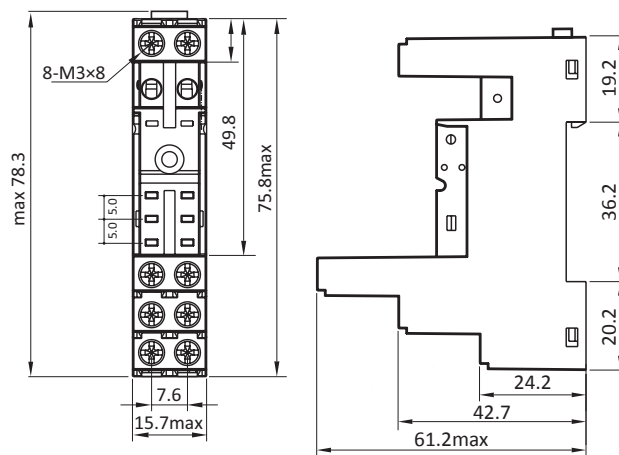

Included Accessories

Retaining / Ejector clip, plastic CP-16

Optional Accessories (modules)

| | |
|--|------------------|
| Free wheeling diode | RD16/DC12-240V |
| Green LED & free wheeling diode, 6-24V DC | RDL16/DC6-24V |
| Green LED & free wheeling diode, 24-60V DC | RDL16/DC24-60V |
| Green LED & free wheeling diode, 110-240V DC | RDL16/DC110-240V |
| Green LED, 6-24V AC/DC | RL16/UC6-24V |
| Green LED, 24-60V AC/DC | RL16/UC24-60V |
| Green LED, 110-240V AC/DC | RL16/UC110-240V |
| RC-Network 6-24V | RC16/UC6-24V |
| RC-Network 24-60V | RC16/UC24-60V |
| RC-Network 110-240V | RC16/UC110-240V |

Technical approvals, conformities



| Socket Selection for industrial Relays | | | | | | | | | | | | | | | | | | | | | | | | | |
|--|-----------------------------|----|----|----|----|----|----|-----|-----|-----------------|-----------|-----|-----|-----|-----|----|----------|-----------------|-----------|-----------|-----|-----|--------------------|---------------|-----|
| Socket Type | Description | C2 | C3 | C4 | C5 | C7 | C9 | C10 | C12 | C16PTL / C18PTL | C18-A15PT | C21 | C22 | C31 | C32 | R7 | R-Module | C52 / C53 / C64 | C55 / C56 | C83 / C85 | CT2 | CT3 | CT32 / CT33 / CT36 | CT515 / CT524 | KDM |
| EC-11 | Socket for industrial Relay | | ● | | | | | | | | | | | ● | ● | | | | | | | | | | |
| S2-B | Socket for industrial Relay | ● | | | | | | | | | | | | | | | | | | | | ● | | | |
| S2-S * | Socket for industrial Relay | ● | | | | | | | | | | ● | ● | | | | | | | | | ● | | | |
| S2-L * | Socket for industrial Relay | ● | | | | | | | | | | | | | | | | | | | | ● | | | |
| S2-P * | Socket for industrial Relay | ● | | | | | | | | | | | | | | | | | | | | ● | | | |
| S2-P0 * | Socket for industrial Relay | ● | | | | | | | | | | | | | | | | | | | | ● | | | |
| S3-B | Socket for industrial Relay | | ● | | | | | | | | | | | ● | ● | | | ● | ● | | | | ● | | |
| S3-MP | Socket for industrial Relay | | ● | | | | | | | | | | | ● | ● | | | ● | ● | | | | ● | | |
| S3-S | Socket for industrial Relay | | ● | | | | | | | | | | | ● | ● | | | ● | ● | | | | ● | | |
| S3-P * | Socket for industrial Relay | | | | | | | | | | | | | | | | | ● | ● | | | | ● | | |
| S3-P0 * | Socket for industrial Relay | | | | | | | | | | | | | | | | | ● | ● | | | | ● | | |
| S3-M0 | Socket for industrial Relay | | ● | | | | | | | | | | | ● | ● | | ● | | | | | | ● | ● | |
| S3-M1 | Socket for industrial Relay | | ● | | | | | | | | | | | ● | ● | | | ● | ● | | | | ● | | |
| S3-M | Socket for industrial Relay | | ● | | | | | | | | | | | ● | ● | | | ● | ● | | | | ● | | |
| S4-J | Socket for industrial Relay | | | ● | | | | | | | | | | | | | | | | | | | | | |
| S4-L | Socket for industrial Relay | | | ● | | | | | | | | | | | | | | | | | | | | | |
| S4-P | Socket for industrial Relay | | | ● | | | | | | | | | | | | | | | | | | | | | |
| S5-M | Socket for industrial Relay | | | | ● | | | | | | | | | | | | | ● | | | | | ● | ● | |
| S5-L | Socket for industrial Relay | | | | ● | | | | | | | | | | | | | | | | | | | | |
| S5-P | Socket for industrial Relay | | | | | | | | | | | | | | | | | | | | | | | | |
| S7-C | Socket for industrial Relay | | | | | ● | | | | | | | | | | | ● | ● | | | ● | | | | ● |
| S7-I0 | Socket for industrial Relay | | | | | ● | | | | | | | | | | | ● | ● | | | | | | | |
| S7-16 | Socket for industrial Relay | | | | | ● | | | | | | | | | | | ● | ● | | | | | | | |
| S7-P * | Socket for industrial Relay | | | | | ● | | | | | | | | | | | ● | | | | | | | | |
| S7-L * | Socket for industrial Relay | | | | | ● | | | | | | | | | | | ● | | | | | | | | |
| S9-M | Socket for industrial Relay | | | | | | ● | | | | | | | | | | | | | | | | | | |
| S9-P | Socket for industrial Relay | | | | | | ● | | | | | | | | | | | | | | | | | | |
| S9-L * | Socket for industrial Relay | | | | | | ● | | | | | | | | | | | | | | | | | | |
| S9-P0 | Socket for industrial Relay | | | | | | | | | | | | | | | | | | | | | | | | |
| S10 | Socket for industrial Relay | | | | | | | ● | | | | | | | | | | | | | | | | | |
| S10-P | Socket for industrial Relay | | | | | | | ● | | | | | | | | | | | | | | | | | |
| S12 | Socket for industrial Relay | | | | | | | | ● | | | | | | | | | | | | | | | | |
| S12-P | Socket for industrial Relay | | | | | | | | ● | | | | | | | | | | | | | | | | |
| S16-M | Socket for industrial Relay | | | | | | | | | ● | | | | | | | | ● | | | | | | | |
| S18-M | Socket for industrial Relay | | | | | | | | | | ● | | | | | | | ● | | | | | | | |

* Discontinued, limited units may be still available from stock.

| Socket Accessoires | | | | | | | | | | | | | | | | | |
|--------------------|---|------|-------|-------|------|------|------|------|-----|-------|-----|------|------|------|------|------|------|
| Type | Description | S3-M | S3-M0 | S3-M1 | S2-B | S3-B | S5-M | S7-C | S10 | S7-I0 | S12 | S9-M | S4-J | S7-L | S7-P | S9-L | S9-P |
| CA-11 | Code Ring (BAG 5 PCS) | | | | | ● | | | | | | | | | | | |
| C-A2 | Neutral-Connector (BAG 5 PCS or 50 PCS) | ● | ● | ● | | | ● | | | | | | | | | | |
| SC-3 | A1-Connector (BAG 10 PCS) | | ● | ● | | | ● | | | | | | | | | | |
| LH-1 | Label carrier transparent (BAG 5 PCS) | ● | ● | ● | | | | | | | | | | | | | |
| SL-36 | Label holder transparent (BAG 5 PCS) | | | | ● | ● | | | | | | | | | | | |
| SP-36 | Labeling strips (BAG 5 PCS) | | | | ● | ● | | | | | | | | | | | |
| L-16 | Labeling strips (BAG 5 PCS) | ● | ● | ● | | | | | | | | | | | | | |
| SD-1T | Lock lid transparent (BAG 5 PCS) | ● | ● | ● | | | ● | | | | | | | | | | |
| SD-1W | Lock lid white (BAG 5 PCS) | ● | ● | ● | | | ● | | | | | | | | | | |
| B20-G | Bridge Bar grey (BAG 5 PCS) | | | | | | | | | | ● | | | | | | |
| B20-R | Bridge Bar red (BAG 5 PCS) | | | | | | | | | | ● | | | | | | |
| B20-A | Bridge Bar blue (BAG 5 PCS) | | | | | | | | | | ● | | | | | | |
| PS-W | Labeling strips | | | | | | | ● | | | | | | | | | |
| S7-BB | Bridge bar (BAG 5 PCS (5 x 4)) | | | | | | | ● | | ● | | | | | | | |
| S9-CH | Labeling srib white (BAG 10 PCS) | | | | | | | | | ● | | ● | | | | | |
| S10-BB | Bridge bar (BAG 20 PCS (5 x 4)) | | | | | | | | ● | | | | | | | | |
| S10-RH | Labeling srib white (BAG 10 PCS) | | | | | | | | ● | | ● | | | | | | |
| S10-RT | Transparent Cover (BAG 20 PCS) | | | | | | | | ● | | | | | | | | |
| SA-0 | Wall Adapter | | | | | | | ● | ● | | ● | | | | | | |
| SS-T | Transparent Cover | | | | | | | ● | | | | | | | | | |
| SS-W | White Cover | | | | | | | ● | | | | | | | | | |
| V10-G | Bridge Bar grey (BAG 5 PCS) | | | | | | | | | | ● | | | | | | |
| V10-R | Bridge Bar red (BAG 5 PCS) | | | | | | | | | | ● | | | | | | |
| V10-A | Bridge Bar blue (BAG 5 PCS) | | | | | | | | | | ● | | | | | | |
| V40-G | Bridge Bar grey (BAG 5 PCS) | | | | | | | | | | ● | | | | | | |
| V40-R | Bridge Bar red (BAG 5 PCS) | | | | | | | | | | ● | | | | | | |
| V40-A | Bridge Bar blue (BAG 5 PCS) | | | | | | | | | | ● | | | | | | |

Retaining clip selection for socket and relay

| Socket type | Made in | C2 ESP | C2 ESP + CT2 | C2 IND | C2 2 IND + CT2 | C3 ESP | C3 ESP + CT3 | C3 IND | C3 ESP + CT3 | C4 ESP | C4 CN | C5 ESP | C5 CN | C7 ESP | C7 CN | C9 ESP | C9 CN | C10 ESP | C10 CN | C10 IND | C12 ESP | C12 IND | C16P/L/C18P/L | C18-A1SPT | C21 | C21 + CT2 | C22 | C22 + CT2 | C31 | C31 + CT3 | C32 | C32 + CT3 | R3 ESP | R3 IND | R7 ESP | R7 CN | | |
|-------------------|---------|-------------------------|----------------|--------|----------------|--------|-------------------------|--------|----------------|--------|-------------------------|--------|-------|--------|-------|--------|-------|---------|--------|---------|---------|---------|---------------|-----------|-----|-----------|-----|-----------|-----|-----------|-----|-----------|--------|--------|--------|-------|--|--|
| EC-8 | ESP | S3-C | HF-32 | | | | S3-C | | HF-32 | | | | | | | | | | | | | | | | | | | | | | | | | | | | | |
| EC-11 | ON | | | | | | | | | | | | | | | | | | | | | | | | | | | | | | | | | | | | | |
| S2-B, S2-S | ON | S3-OM CP-15B S3-C | S3-OM HF-32 | S3-CT | | HF-33 | | | | | | | | | | | | | | | | | | | | | | | | | | | | | | | | |
| S20-B | ESP | S3-OM CP-15B S3-C | S3-OM HF-32 | S3-CT | | HF-33 | | | | | | | | | | | | | | | | | | | | | | | | | | | | | | | | |
| S2-L, S2-P, S2-PO | ESP | S3-C | HF-32 | | | | | | | | | | | | | | | | | | | | | | | | | | | | | | | | | | | |
| S3-B | ON | | | | | | S3-OM CP-15B S3-C | S3-CT | S3-OM HF-32 | HF-33 | | | | | | | | | | | | | | | | | | | | | | | | | | | | |
| S30-B | ESP | | | | | | S3-OM CP-15B S3-C | S3-CT | S3-OM HF-32 | HF-33 | | | | | | | | | | | | | | | | | | | | | | | | | | | | |
| S3-MP | ESP | | | | | | S3-OM CP-15B S3-C | S3-CT | S3-OM HF-32 | HF-33 | | | | | | | | | | | | | | | | | | | | | | | | | | | | |
| S3-S | ON | | | | | | S3-OM CP-15B S3-C | S3-CT | S3-OM HF-32 | HF-33 | | | | | | | | | | | | | | | | | | | | | | | | | | | | |
| S3-L, S3-P, S3-PO | ESP | | | | | | S3-C | | HF-32 | | | | | | | | | | | | | | | | | | | | | | | | | | | | | |
| S3-M0 | ESP | | | | | | S3-C | S3-CT | HF-32 | HF-33 | | | | | | | | | | | | | | | | | | | | | | | | | | | | |
| S4-J | ON | | | | | | S3-OM CP-15B S3-C | | | | S3-OM CP-15B S3-C | | | | | | | | | | | | | | | | | | | | | | | | | | | |
| S4-L, S4-P, S4-PO | ESP | | | | | | S4-CL | | | | S4-CL | | | | | | | | | | | | | | | | | | | | | | | | | | | |
| S5-S | ESP | | | | | | | | | | | | | | | | | | | | | | | | | | | | | | | | | | | | | |
| S5-M | ON | | | | | | | | | | | | | | | | | | | | | | | | | | | | | | | | | | | | | |
| S7-C | ON | | | | | | | | | | | | | | | | | | | | | | | | | | | | | | | | | | | | | |
| S7-H0 | ESP | | | | | | | | | | | | | | | | | | | | | | | | | | | | | | | | | | | | | |
| S7-H0 | ON | | | | | | | | | | | | | | | | | | | | | | | | | | | | | | | | | | | | | |
| S7-16 | ESP | | | | | | | | | | | | | | | | | | | | | | | | | | | | | | | | | | | | | |
| S7-P | | | | | | | | | | | | | | | | | | | | | | | | | | | | | | | | | | | | | | |
| S7-L, S7-PO | ESP | | | | | | | | | | | | | | | | | | | | | | | | | | | | | | | | | | | | | |
| S9-M | ON | | | | | | | | | | | | | | | | | | | | | | | | | | | | | | | | | | | | | |
| S9-P | | | | | | | | | | | | | | | | | | | | | | | | | | | | | | | | | | | | | | |
| S9-L, S9-PO | ESP | | | | | | | | | | | | | | | | | | | | | | | | | | | | | | | | | | | | | |
| S10 | ON | | | | | | | | | | | | | | | | | | | | | | | | | | | | | | | | | | | | | |
| S10-P | ON | | | | | | | | | | | | | | | | | | | | | | | | | | | | | | | | | | | | | |
| S12 | ON | | | | | | | | | | | | | | | | | | | | | | | | | | | | | | | | | | | | | |
| S12-P | ESP | | | | | | | | | | | | | | | | | | | | | | | | | | | | | | | | | | | | | |
| S16-M | ON | | | | | | | | | | | | | | | | | | | | | | | | | | | | | | | | | | | | | |
| S18-M | ON | | | | | | | | | | | | | | | | | | | | | | | | | | | | | | | | | | | | | |